

MICROZED A V3.1 BOARD

S.&A.S. Ltd.
 Jieh Chouf
 Lebanon
 support@sascontrollers.com

MICROZED A WIRING DIAG: VVVF - SUPPLY & OUTPUTS

Size B	FCSM No. -	DWG No. B310VX2_V1W1_SUPPLY.Sch	Rev 1
Scale -	Sheet 1 of 7		

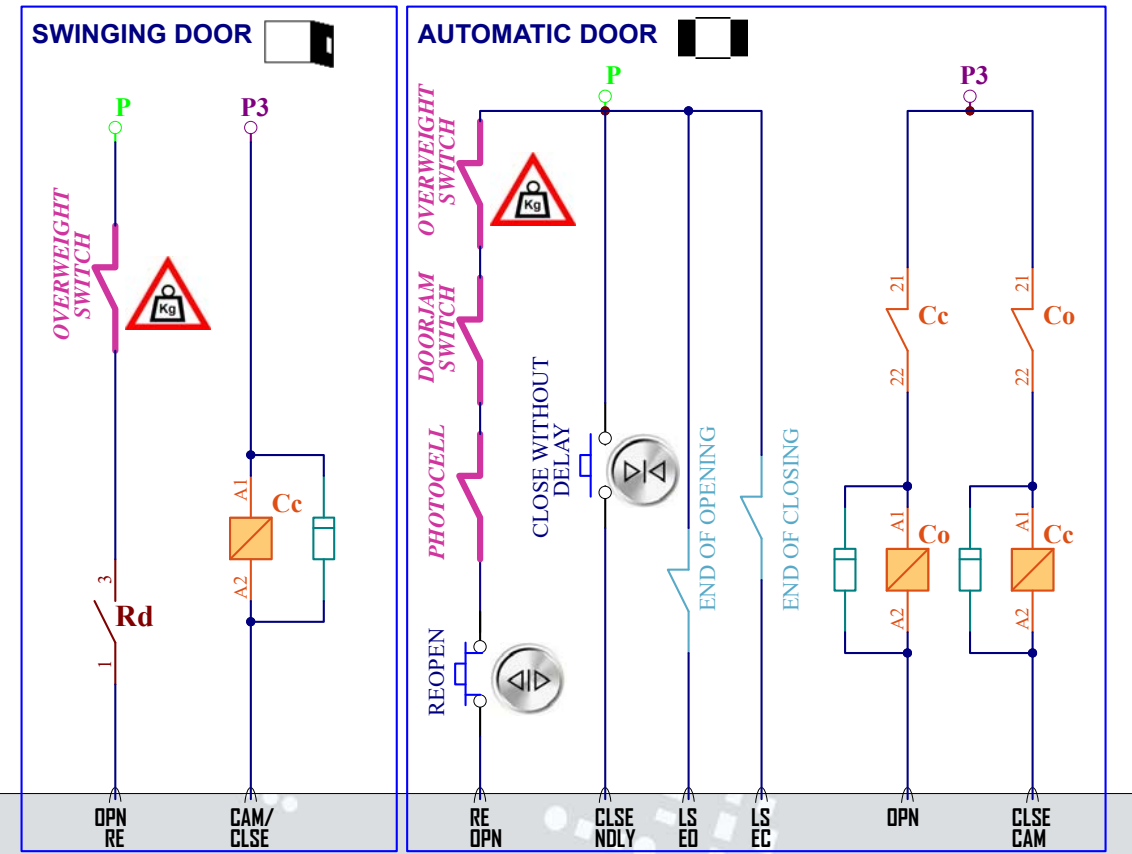
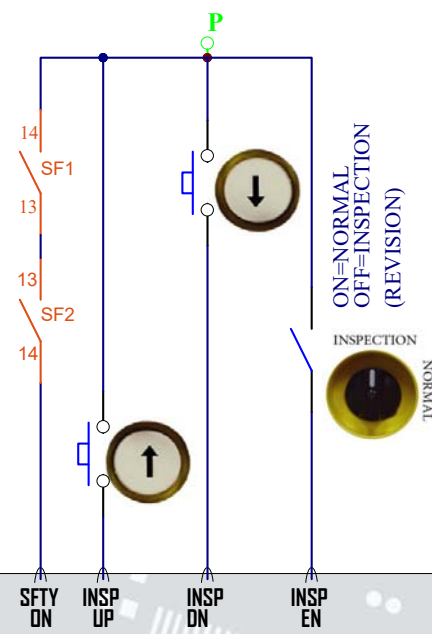
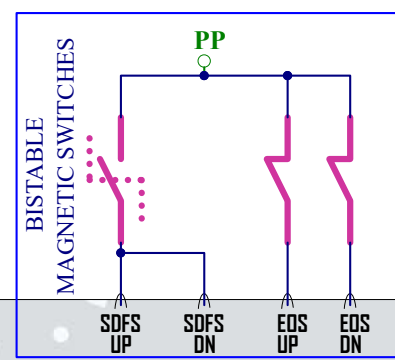
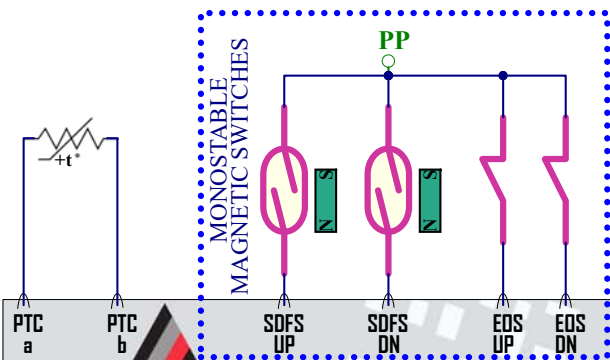
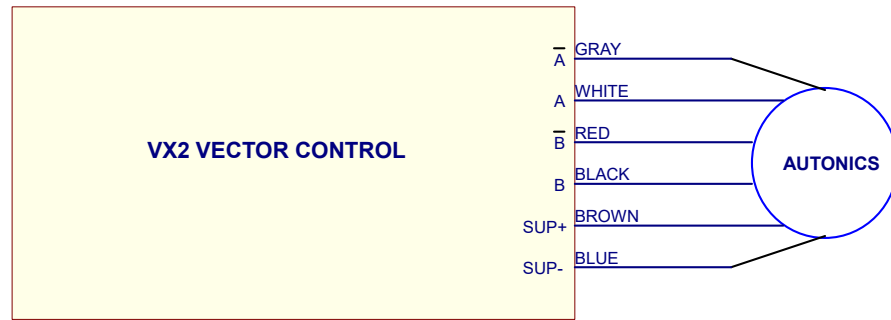
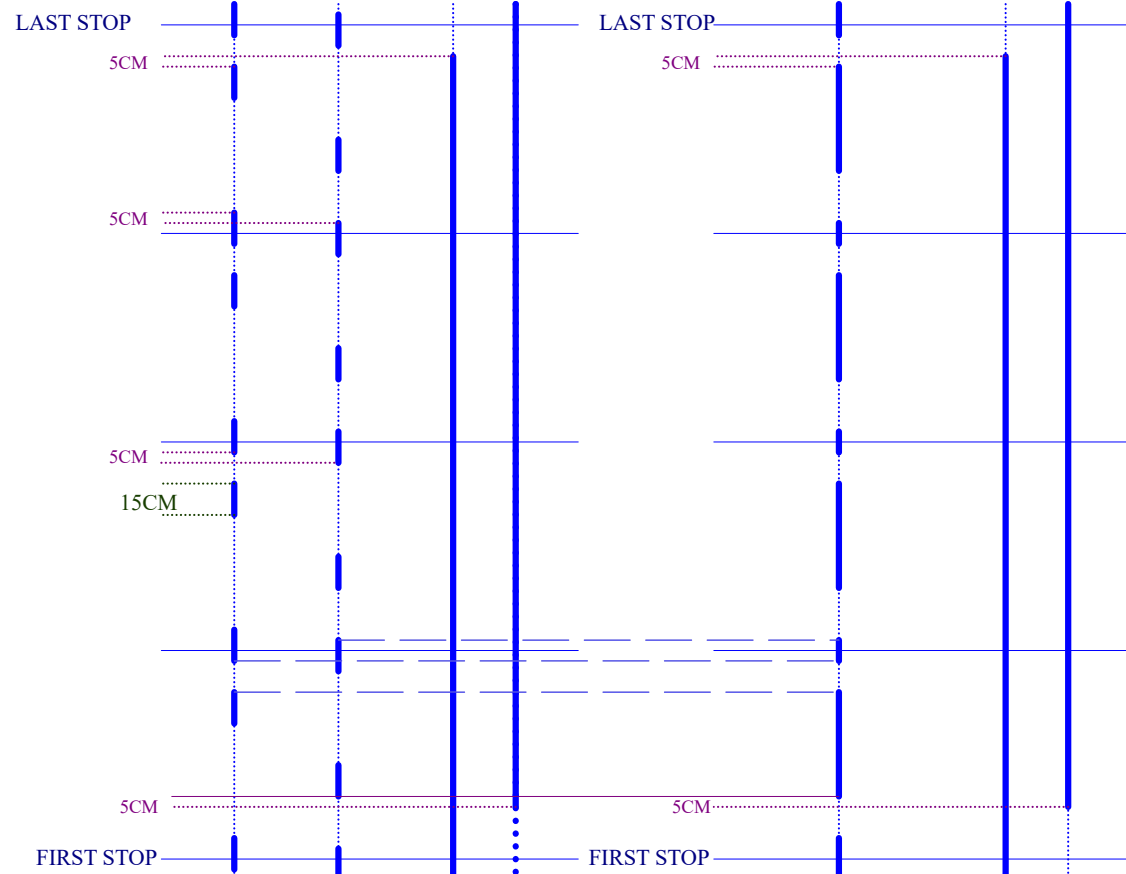

MICROZED A V3.1 BOARD



Note:
1- Use the Monostable Magnetic Switches configuration for Automatic door.

S.&A.S. Ltd.
Jieh Chouf
Lebanon
support@sascontrollers.com

MICROZED A WIRING DIAG: [INPUTS/DOOR INFO](#)

Size B	FCSM No.	DWG No. B310AW2_VX2_INPUTS.Sch	Rev 1
Scale	Sheet 2 of 7		

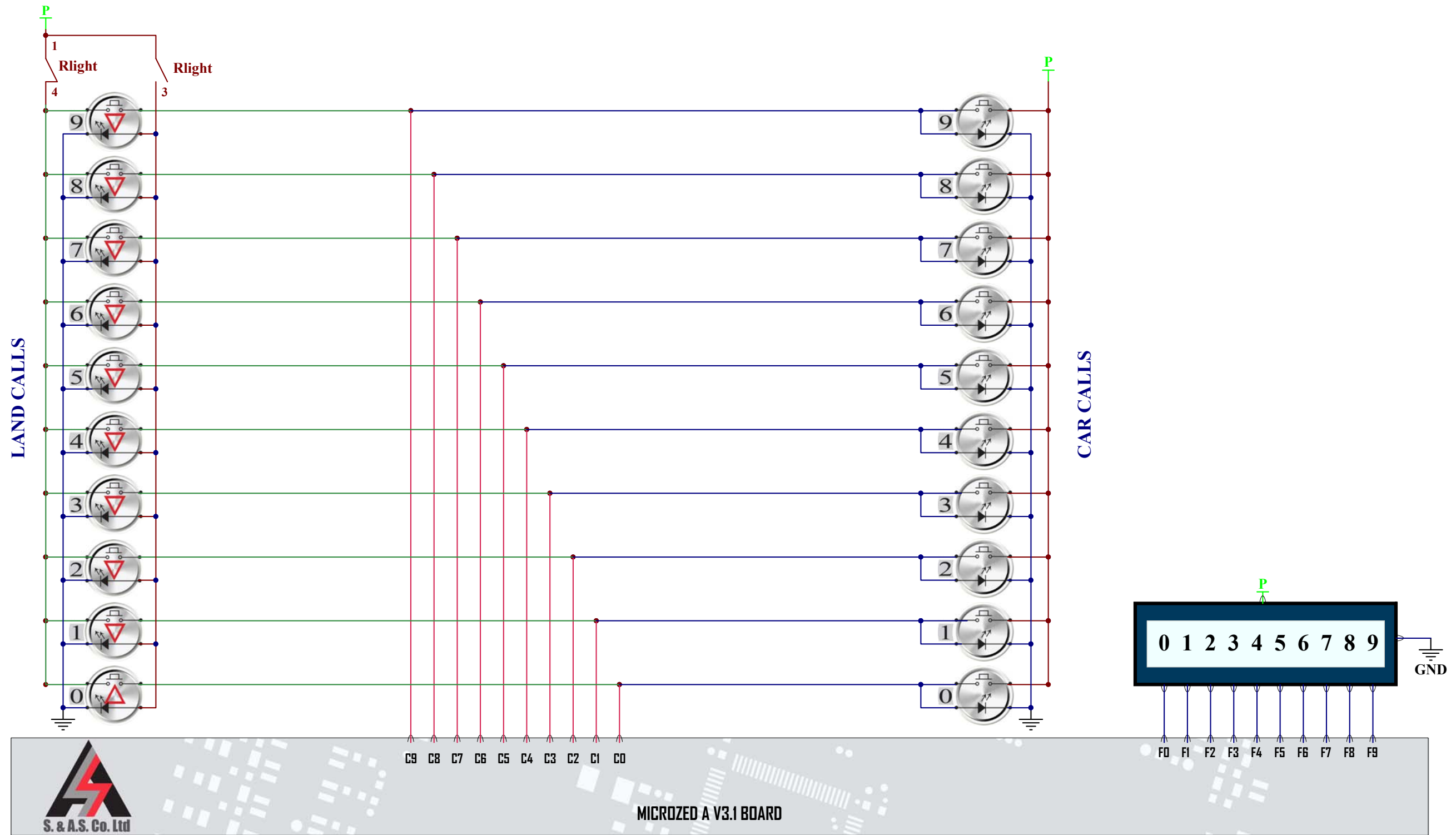

INDICATR="DECIMAL"

S.&A.S. Ltd.
 Jieh Chouf
 Lebanon
 support@sascontrollers.com

MICROZED A WIRING DIAG: CALLS / FLOOR INFORMATION

Decimal Indicator - No Call Register

Size B	FCSM No.	DWG No. B310AW3_VX2_Calls.Sch	Rev 1
Scale	Sheet		3 of 7

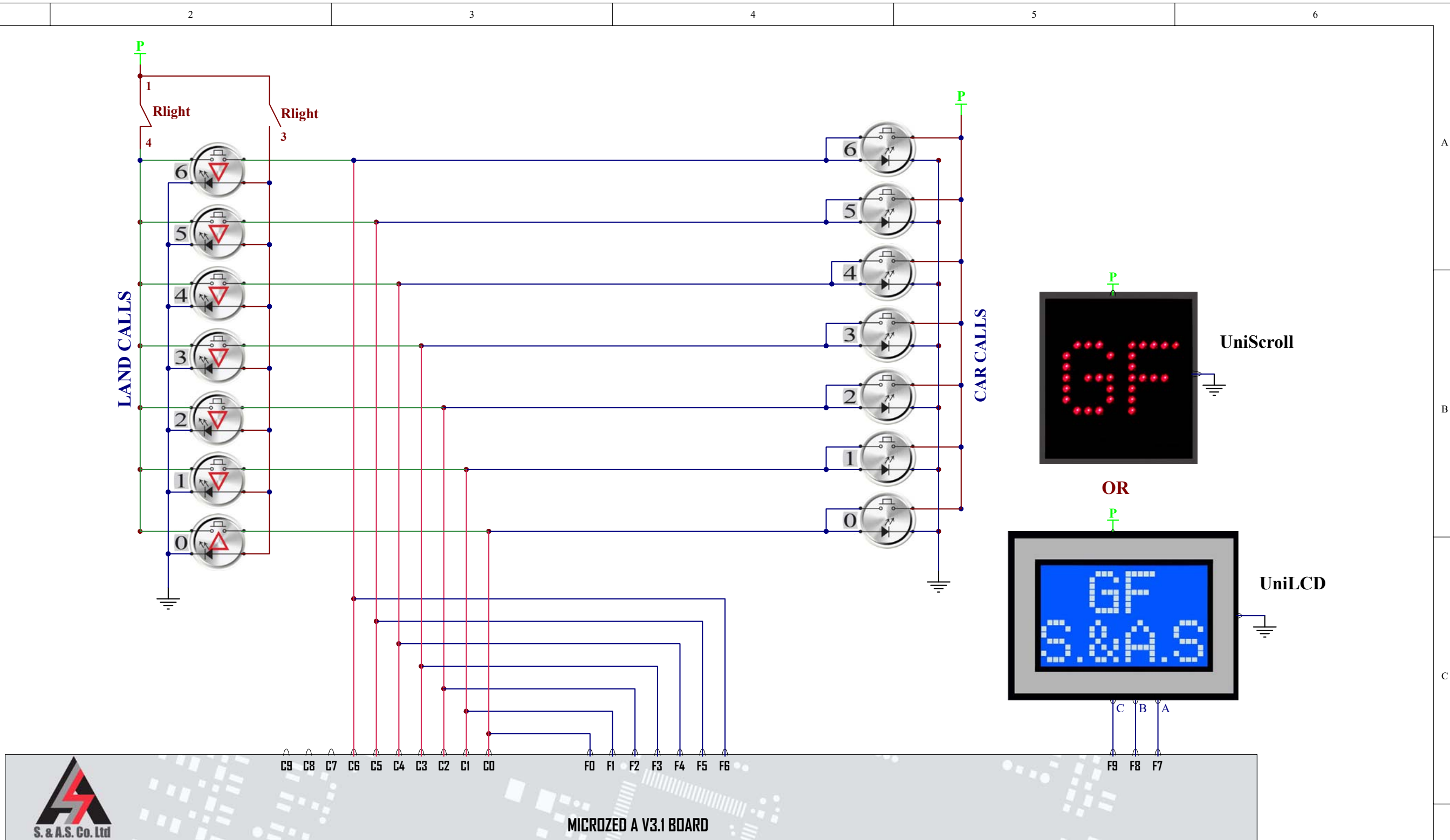

INDICATR="COLLECT7" or
 INDICATR="GRAY R" or
 INDICATR="BINARY R"

S.&A.S. Ltd.
 Jieh Chouf
 Lebanon
 support@sascontrollers.com

MICROZED A WIRING DIAG: **CALLS / FLOOR INFORMATION**

Gray/ Binary/ Collective with Call Register

Size B	FCSM No.	DWG No. B310AW4_VX2_Calls.Sch	Rev 1
Scale	Sheet		4 of 7

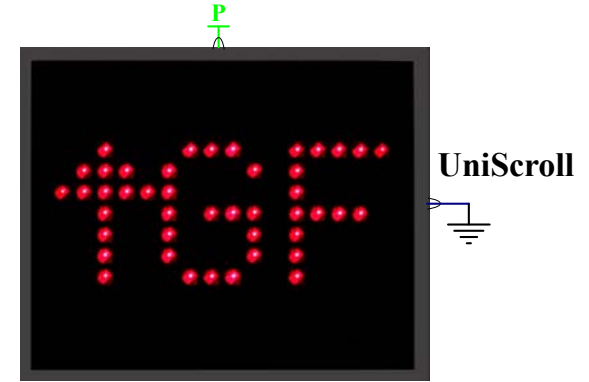
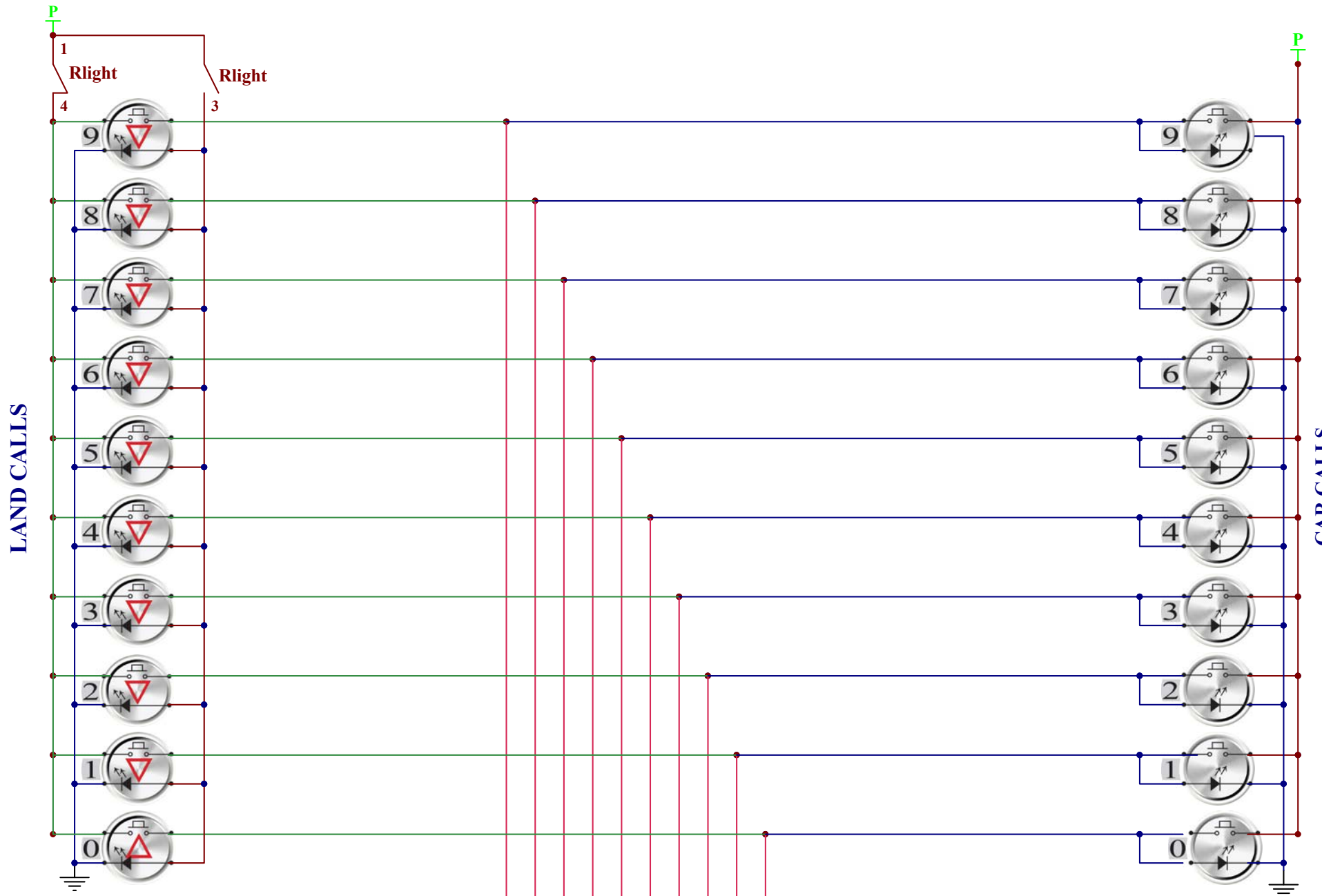

OR

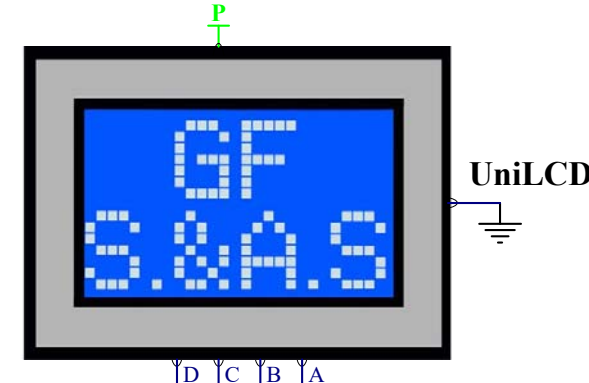

MICROZED A V3.1 BOARD

INDICATR="GRAY NR" or
INDICATR="BINARY NR"

S.&A.S. Ltd.
Jieh Chouf
Lebanon
support@sascontrollers.com

MICROZED A WIRING DIAG: **CALLS / FLOOR INFORMATION**
Binary/Gray Indicator - No Call Register

Size B	FCSM No.	DWG No. B310AW5_VX2_Calls.Sch	Rev 1
Scale	Sheet		5 of 7

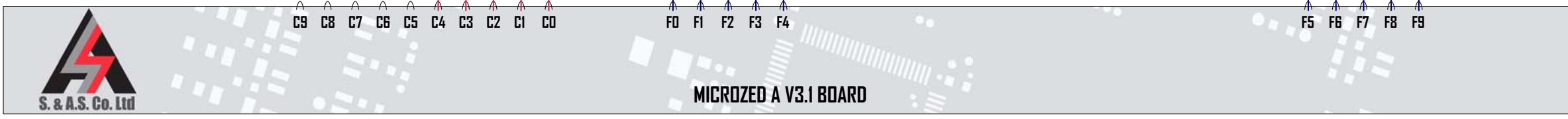
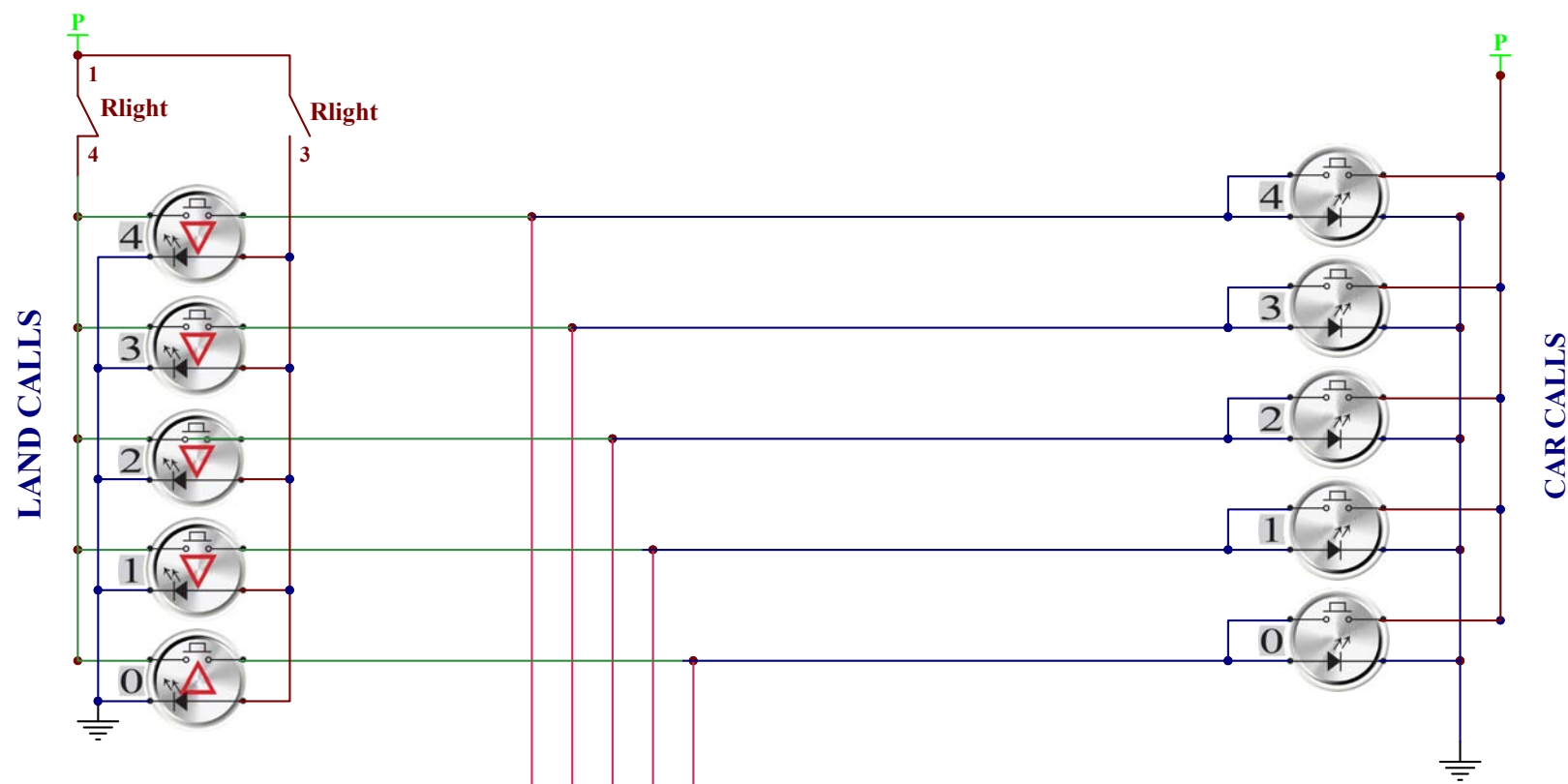

MICROZED A V3.1 BOARD

INDICATR="COLLECTD"		S.&A.S. Ltd. Jieh Chouf Lebanon support@sascontrollers.com	
MICROZED A WIRING DIAG: CALLS / FLOOR INFORMATION			
Decimal Indicator with Call Register			
Size B	FCSM No.	DWG No. B310AW6_VX2_Calls.Sch	Rev 1
Scale		Sheet	6 of 7

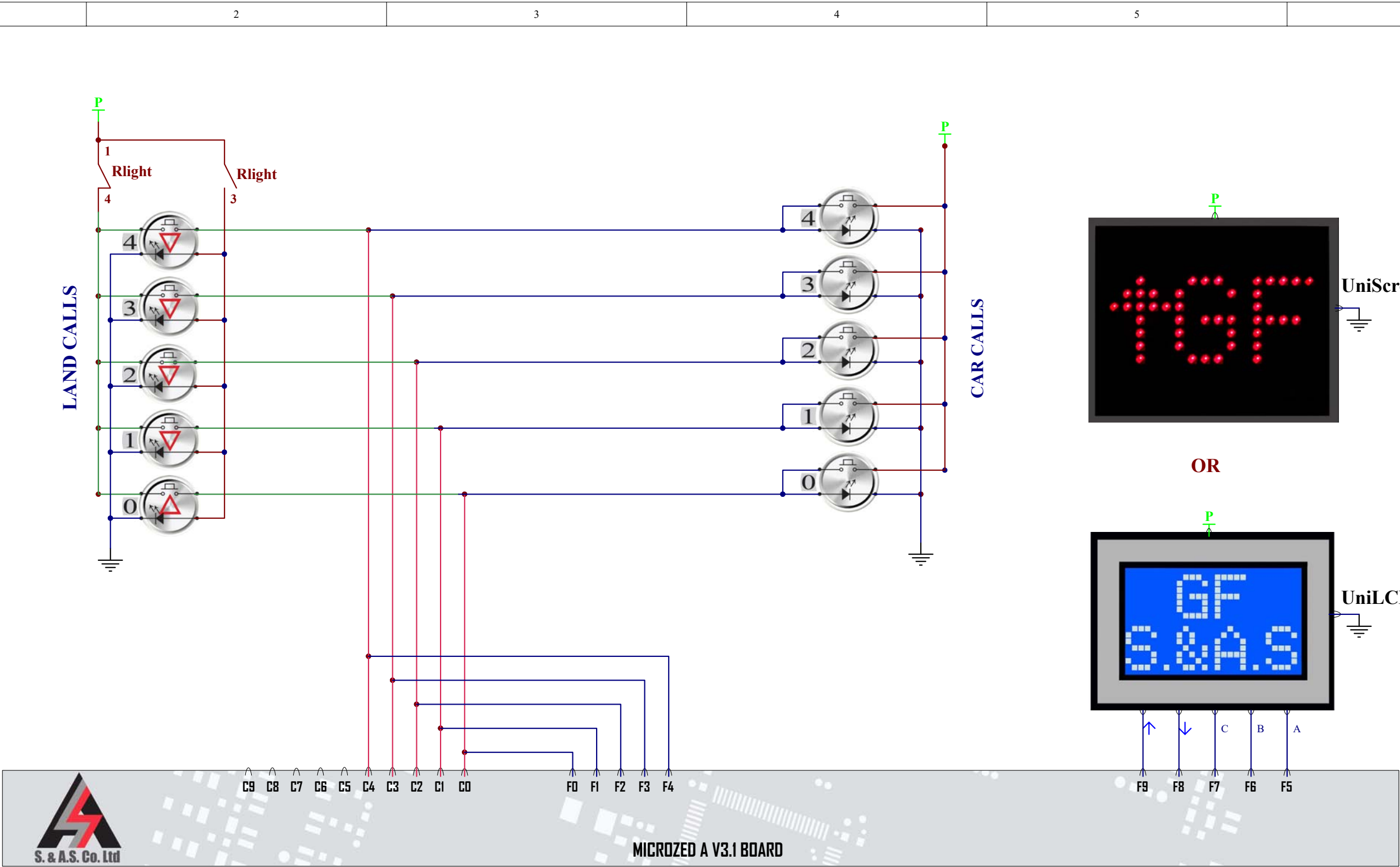

INDICATR="ENHANCED"

S.&A.S. Ltd.
 Jieh Chouf
 Lebanon
 support@sascontrollers.com

MICROZED A WIRING DIAG: CALLS / FLOOR INFORMATION

S.&A.S. Indicator with Call Register

Size B	FCSM No.	DWG No. B310AW7_VX2_Calls.Sch	Rev 1
Scale	Sheet		7 of 7