

MICROZED A V3.1 BOARD

S.&A.S. Ltd.  
 Jieh Chouf  
 Lebanon  
 support@sascontrollers.com

MICROZED A WIRING DIAG: VVVF - SUPPLY & OUTPUTS

Size B	FCSM No. -	DWG No. B310VX2_V1W1_SUPPLY.Sch	Rev 1
Scale -	Sheet 1 of 7		

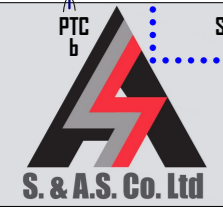
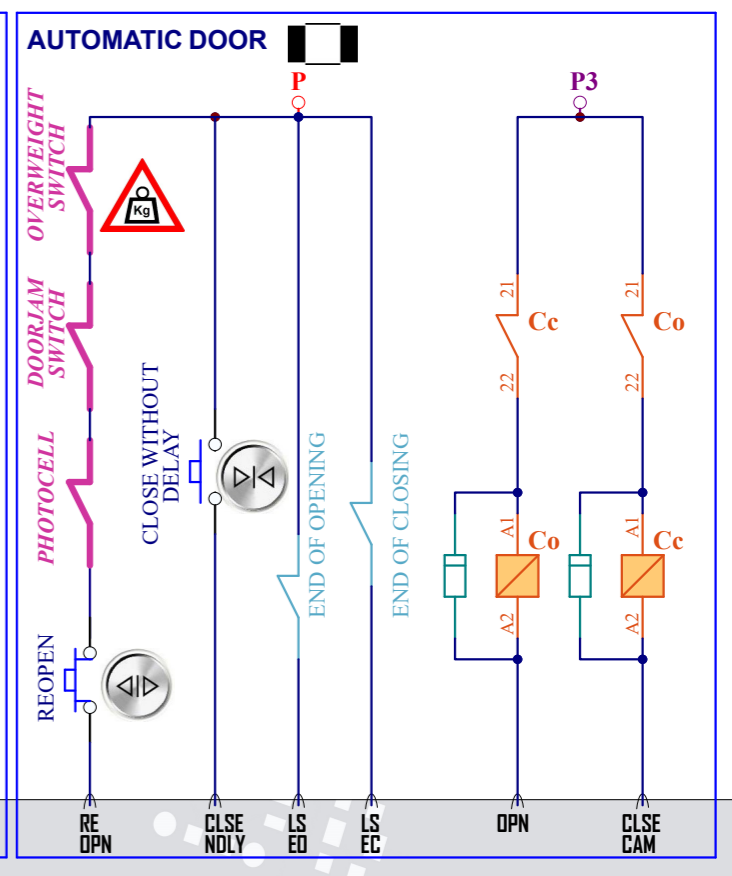
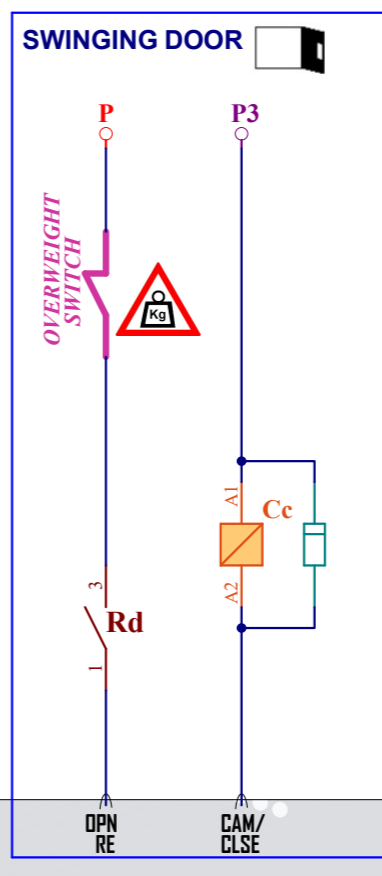
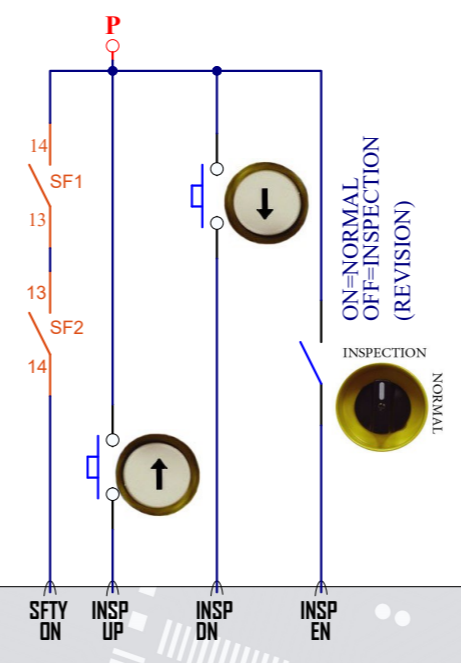
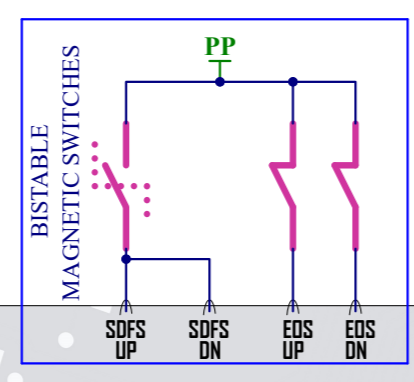
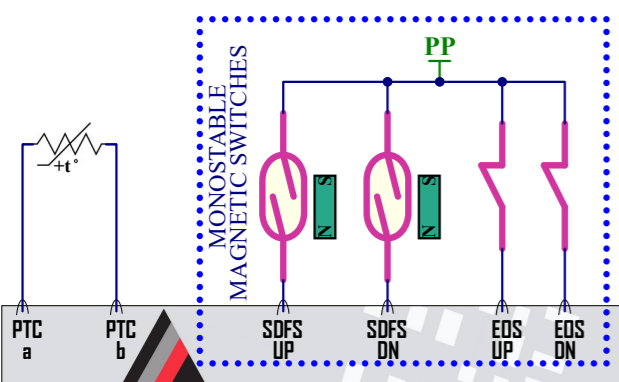
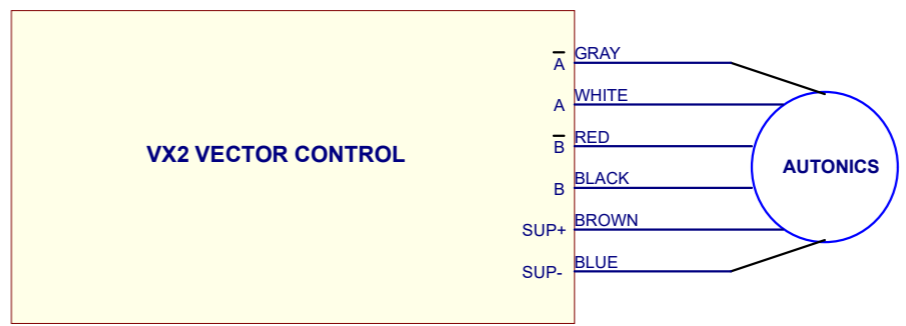
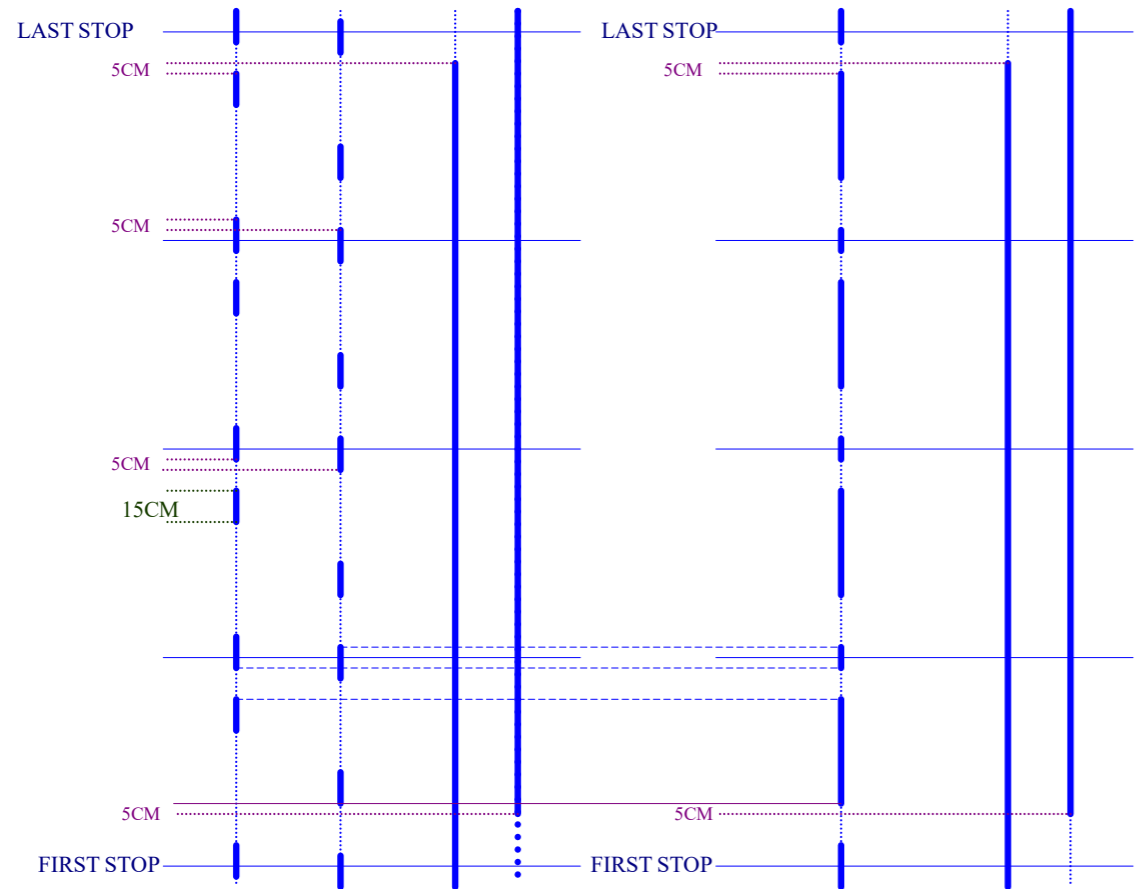

MICROZED A V3.1 BOARD

Note:  
1- Use the Monostable Magnetic Switches configuration for Automatic door.

S.&A.S. Ltd.  
Jieh Chouf  
Lebanon  
support@sascontrollers.com

MICROZED A WIRING DIAG: [INPUTS/DOOR INFO](#)

Size B	FCSM No.	DWG No. B310AW2_VX2_INPUTS.Sch	Rev 1
Scale	Sheet 2 of 7		

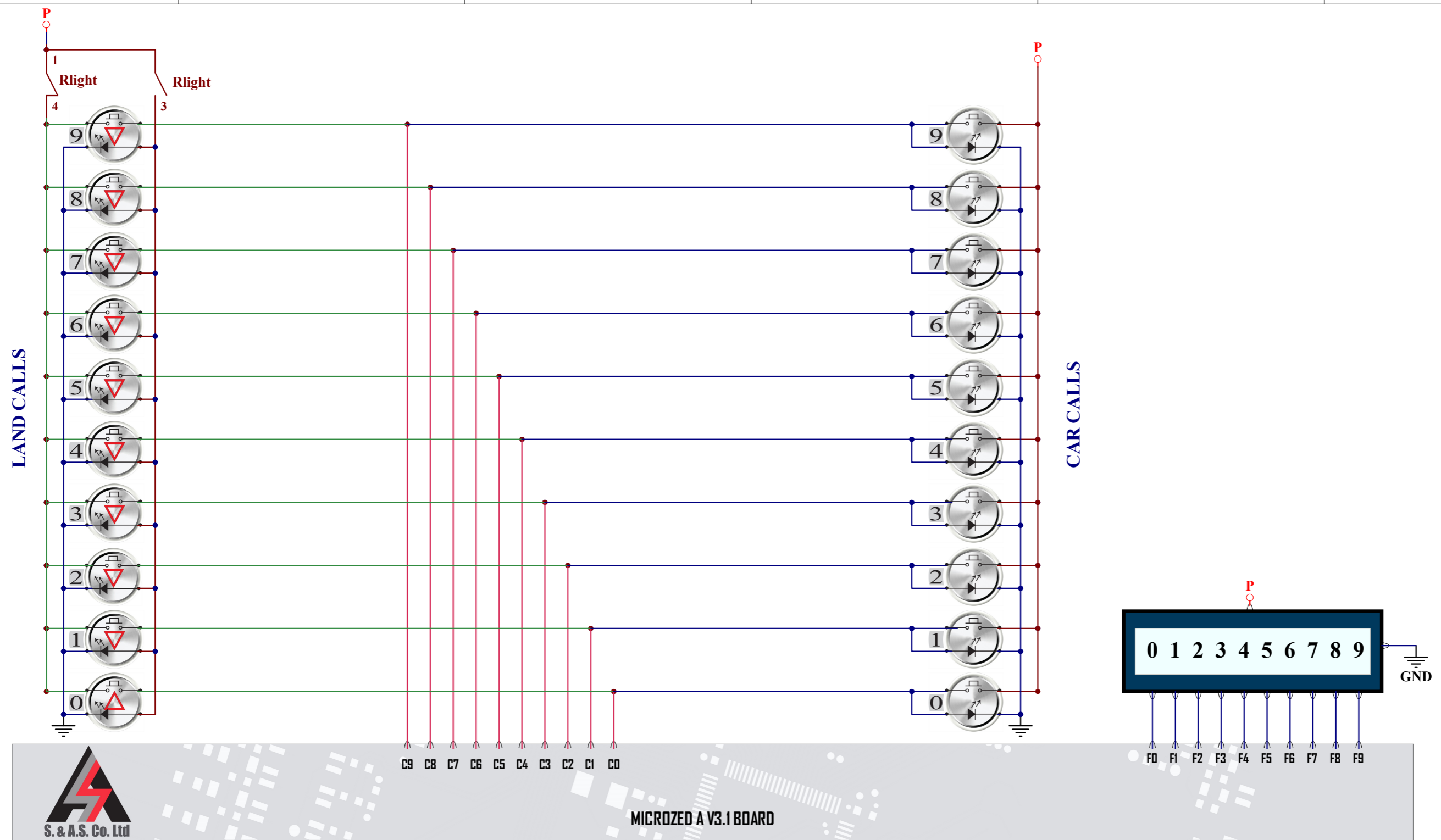

MICROZED A V3.1 BOARD

INDICATR="DECIMAL"

S.&A.S. Ltd.  
Jieh Chouf  
Lebanon  
support@sascontrollers.com

MICROZED A WIRING DIAG: CALLS / FLOOR INFORMATION

Decimal Indicator - No Call Register

Size B	FCSM No.	DWG No. B310AW3_VX2_Calls.Sch	Rev 1
Scale	Sheet		3 of 7

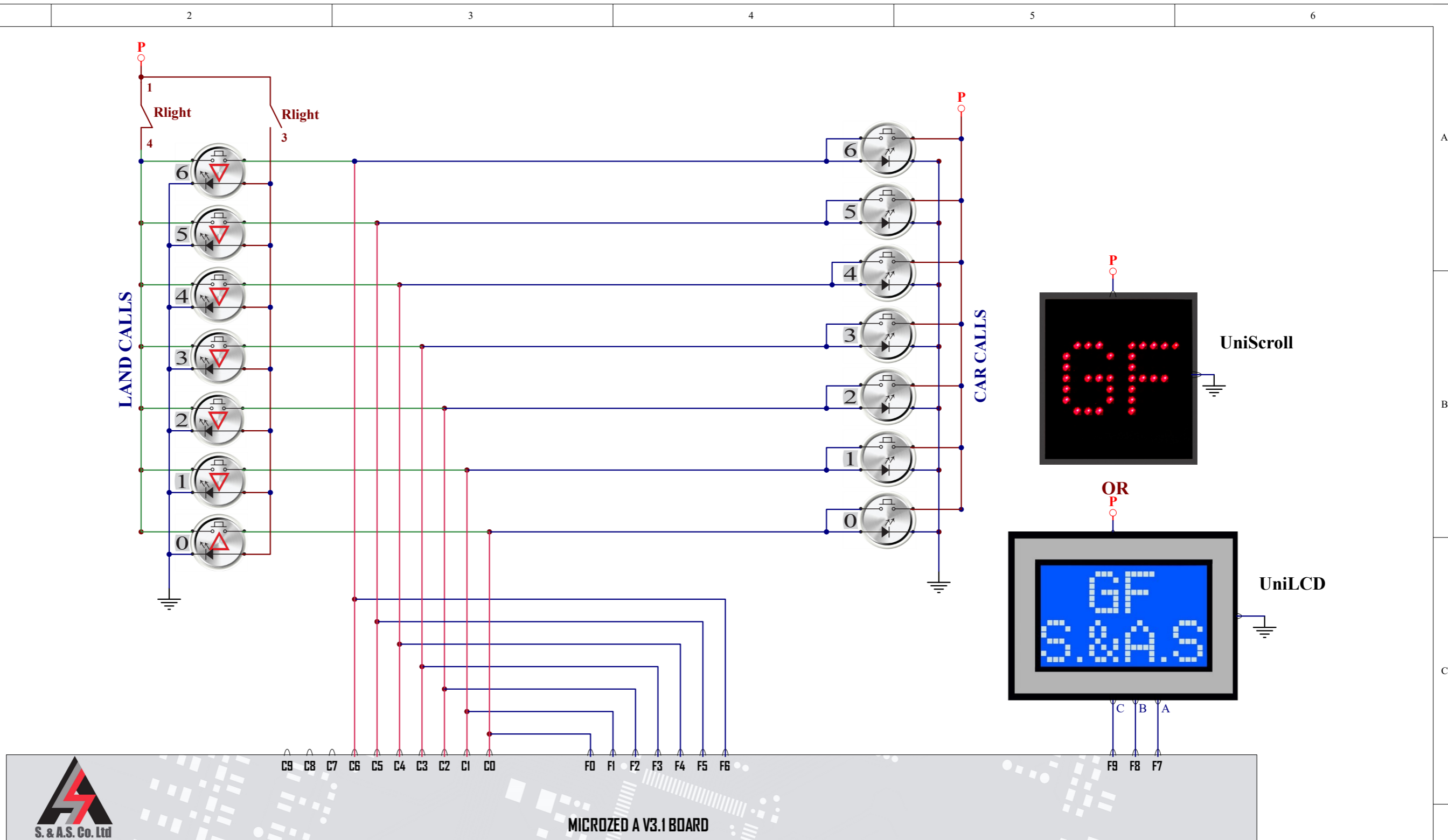

MICROZED A V3.1 BOARD

INDICATR="COLLECT7" or  
INDICATR="GRAY R" or  
INDICATR="BINARY R"

S.&A.S. Ltd.  
Jieh Chouf  
Lebanon  
support@sascontrollers.com

MICROZED A WIRING DIAG: CALLS / FLOOR INFORMATION  
Gray/ Binary/ Collective with Call Register

Size B	FCSM No.	DWG No. B310AW4_VX2_Calls.Sch	Rev 1
Scale	Sheet		4 of 7

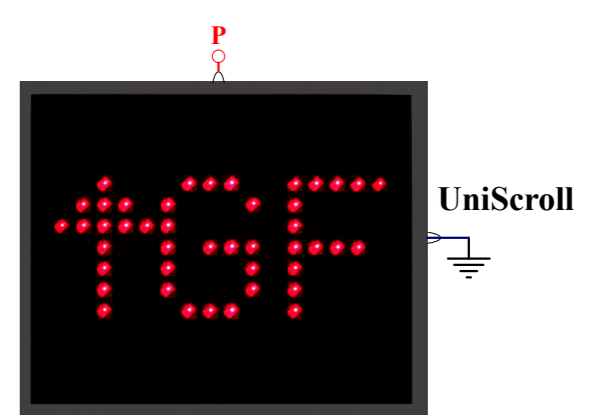
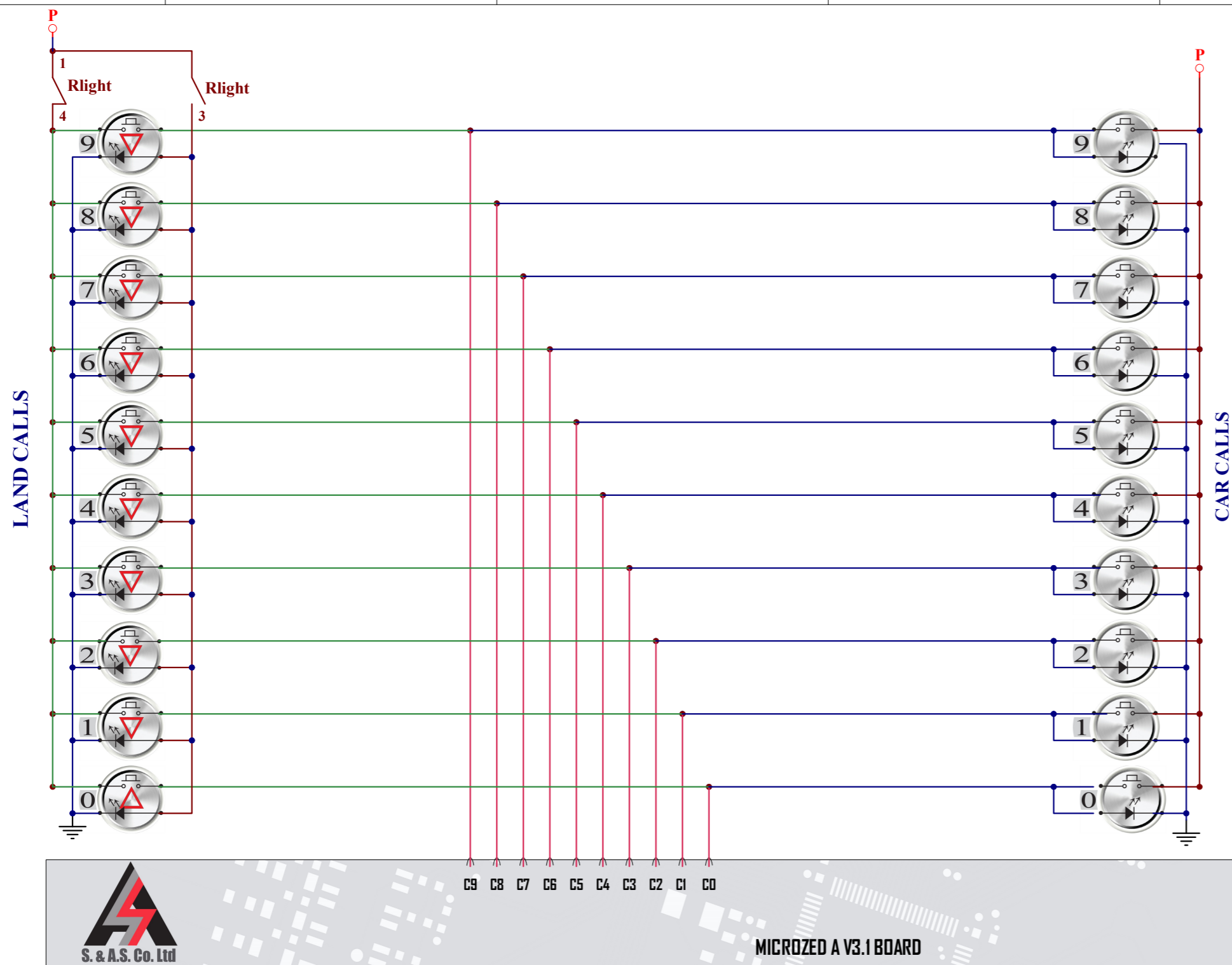

OR





C9 C8 C7 C6 C5 C4 C3 C2 C1 C0

F9 F8 F7 F6

**MICROZED A V3.1 BOARD**

INDICATR="GRAY NR" or INDICATR="BINARY NR"		S.&A.S. Ltd. Jieh Chouf Lebanon support@sascontrollers.com	
<b>MICROZED A WIRING DIAG: CALLS / FLOOR INFORMATION</b> <b>Binary/Gray Indicator - No Call Register</b>			
Size B	FCSM No. -	DWG No. B310AW5_VX2_Calls.Sch	Rev 1
Scale -	Sheet 5 of 7		

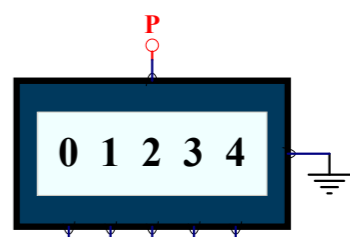
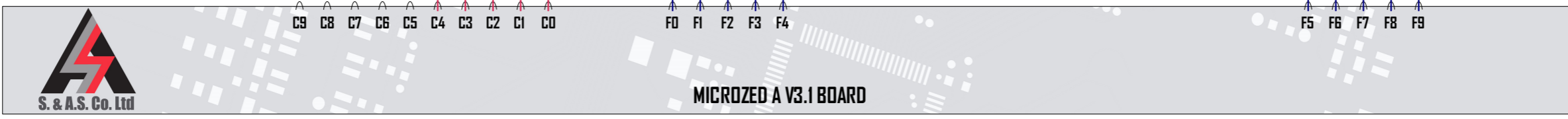
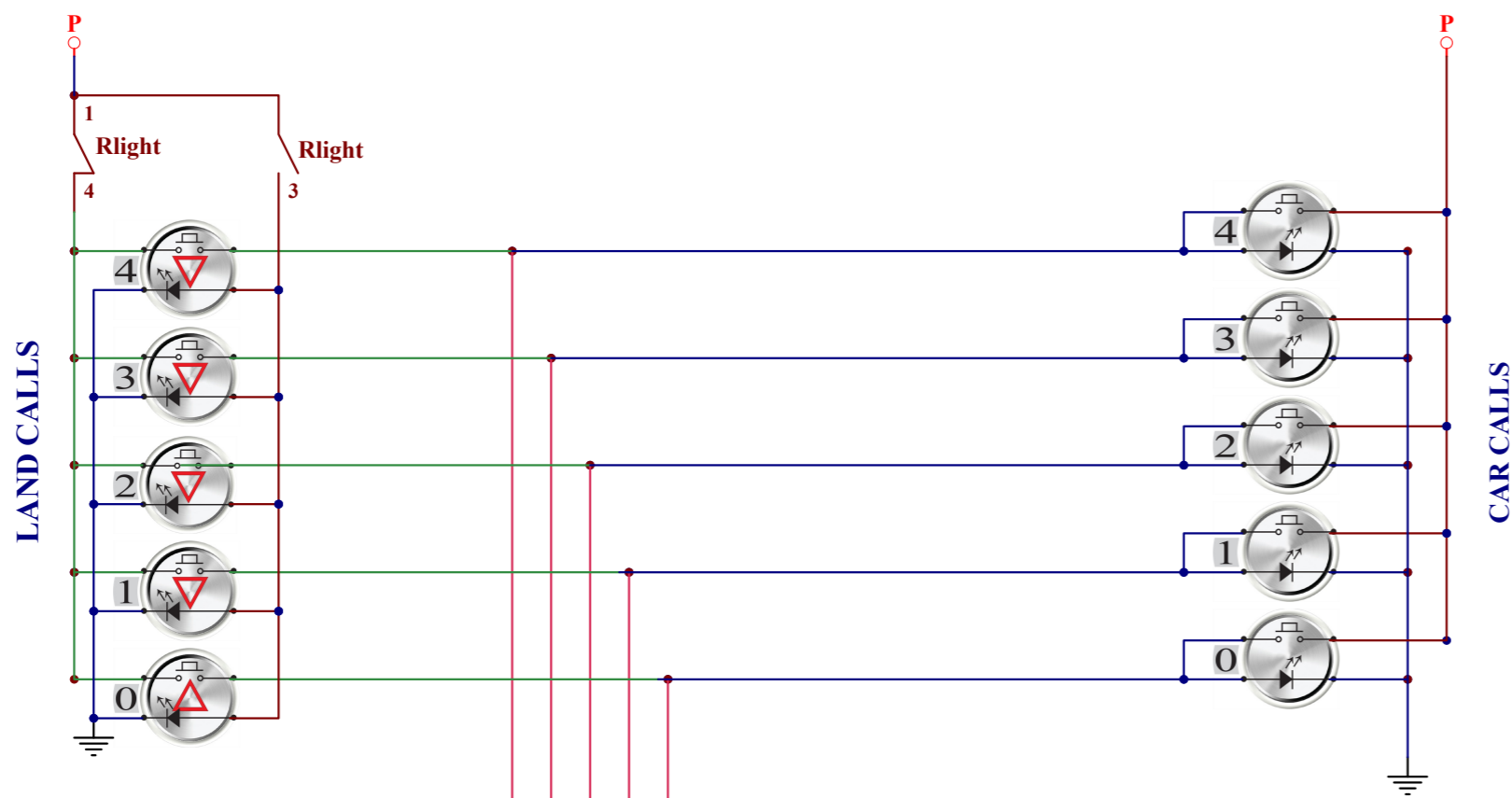

INDICATR="COLLECTD"		S.&A.S. Ltd. Jieh Chouf Lebanon support@sascontrollers.com	
MICROZED A WIRING DIAG: CALLS / FLOOR INFORMATION			
<b>Decimal Indicator with Call Register</b>			
Size B	FCSM No. -	DWG No. B310AW6_VX2_Calls.Sch	Rev 1
Scale -	Sheet 6 of 7		

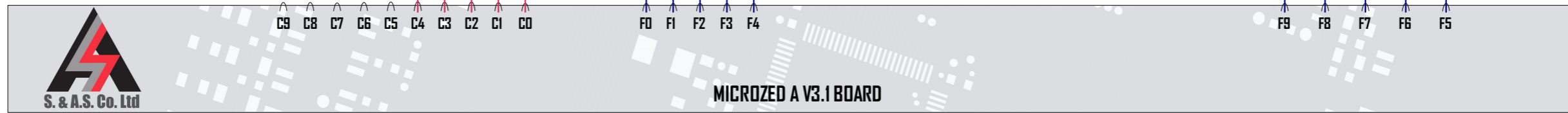
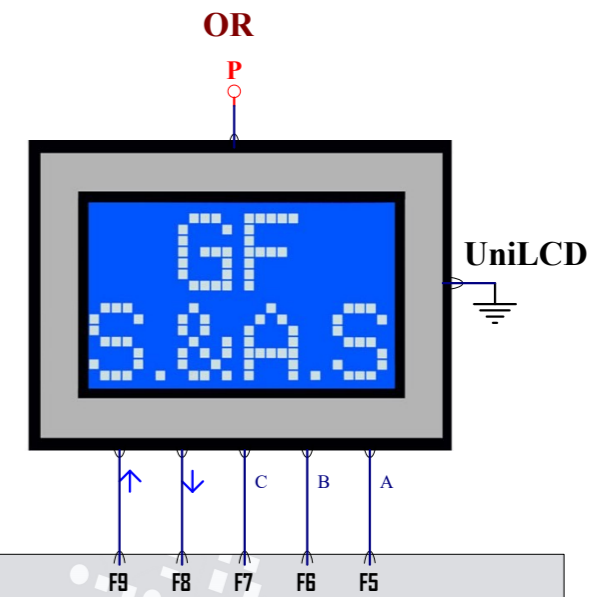
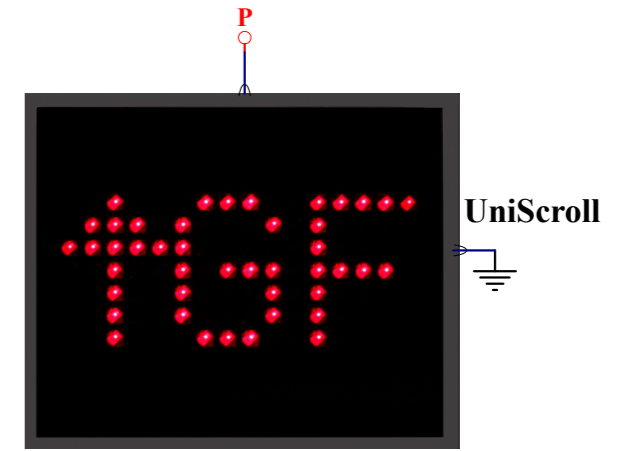
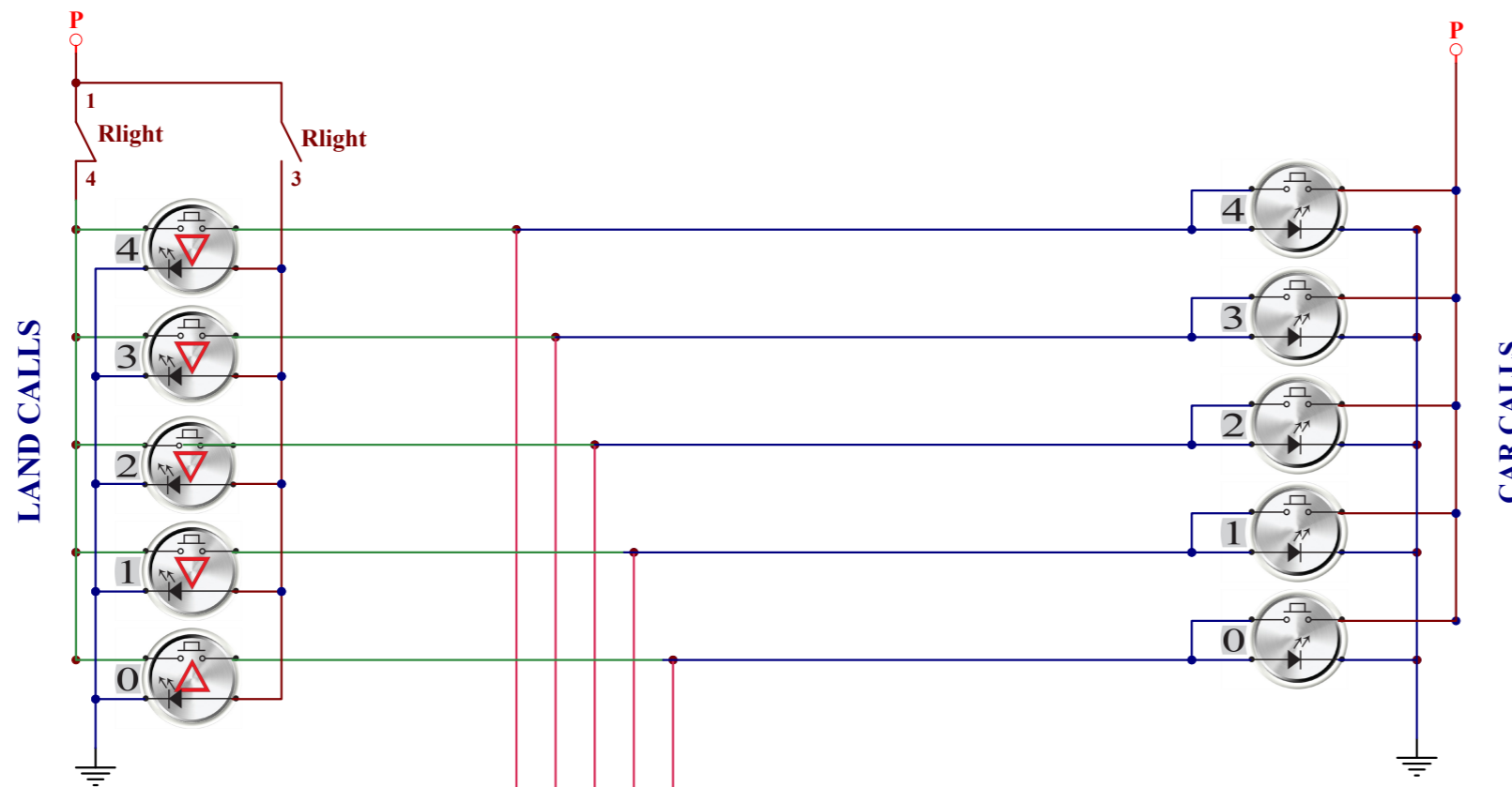

INDICATR="ENHANCED"		S.&A.S. Ltd. Jieh Chouf Lebanon support@sascontrollers.com	
MICROZED A WIRING DIAG: CALLS / FLOOR INFORMATION			
S.&A.S. Indicator with Call Register			
Size B	FCSM No.	DWG No. B310AW7_VX2_Calls.Sch	Rev 1
Scale		Sheet	7 of 7